

5 GAMBLER 2013 TOOLSET

GAMBLER 2013 TOOLSET

To repair or replace the bearings of the pivot points of Gambler we offer following articles:

22xxxx	Swingarm Tool Set Gambler 2013
229705	Bearing Set Gambler 2013
229706	Floating Link Gambler 2013
229707	Main Link Gambler 2013

The tool set will contain, beside all tools in stainless steel quality, a CD showing all steps of the bearing disassembly and assembly as well as all needed technical data as e.g. tightening torques etc.

The Swingarm Rep Set will contain beside the bearings all nuts and bolts to replace all moving parts or parts of wear and tear of a Gambler bike.

Pls have a look at following pics giving you an overview about all needed steps and please make sure to use Loctite BLUE (still removable) on all screws:

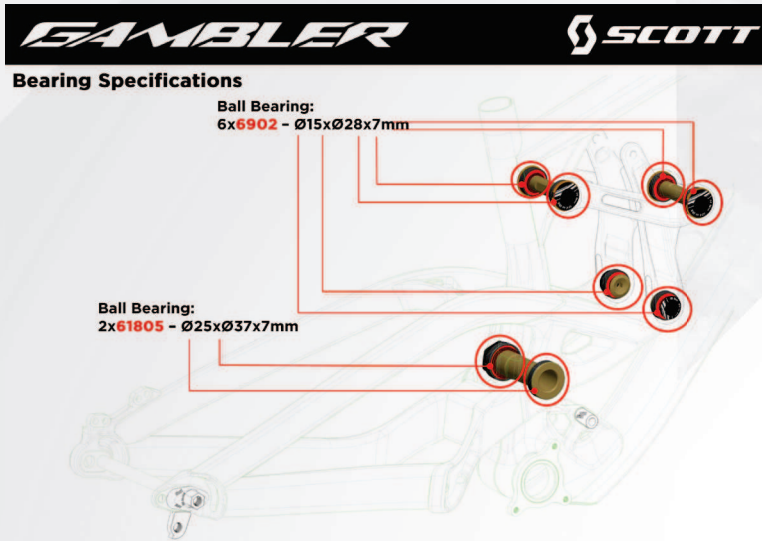











SCOTT SUMMER 2013
TECH WORKSHOP

GAMBLER			SCOTT	
Scott Bearing Service Kit Contents				
M8 x 55 Bolt, Nut, Washers		6902 Bearing Tube		Axle Punch
6902 Plate - Linkage Bearings		6902 Press - Linkage Bearings		
61805 Plate - Main Pivot Bearings		61805 Press - Main Pivot Bearings		
		6902 Bearing Punch		
		61805 Bearing punch		

GAMBLER 2013 TOOLSET



Required Tools			
Nylon Hammer 		Circlip pliers 	
13mm Spanner 		32mm Spanner 	
Torque Wrench 		6mm Allen Key 	
6mm Allen Key Socket 	10mm Allen Key Socket 	Loctite - Blue/ Medium 	Grease 



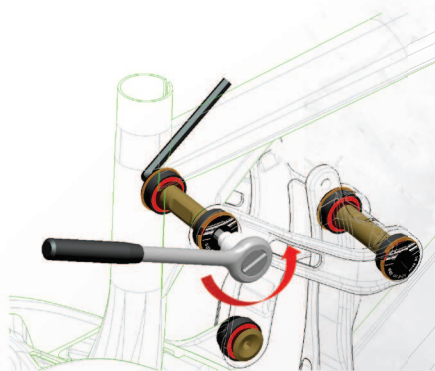

Linkage Pivot Disassemble

Torque Wrench 	6mm Allen Key Socket 	6mm Allen Key 
---	--	---



Linkage Pivot Disassemble

Axle Punch 	Nylon Hammer 
--	--

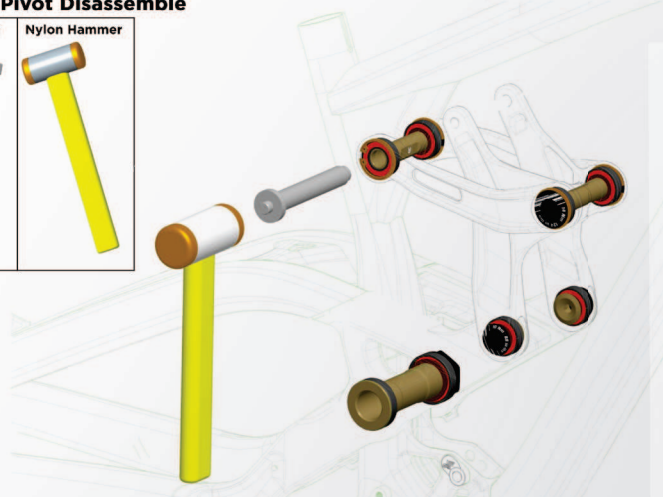

GAMBLER 2013 TOOLSET



Linkage Pivot Disassemble

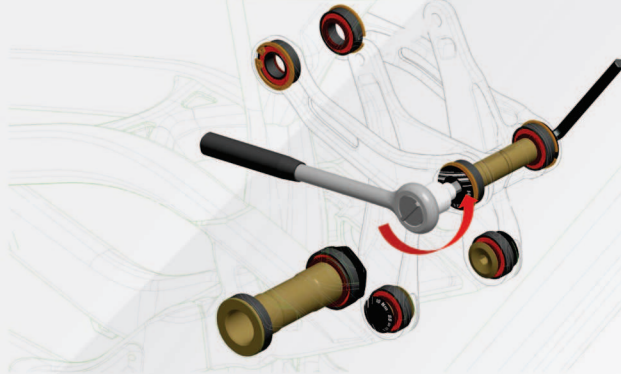

Linkage Pivot Disassemble

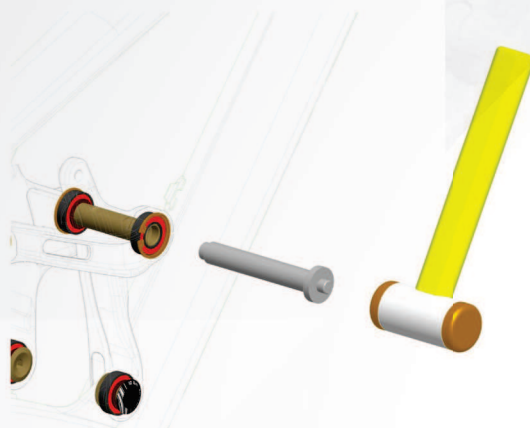
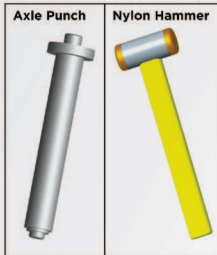

Linkage Disassemble

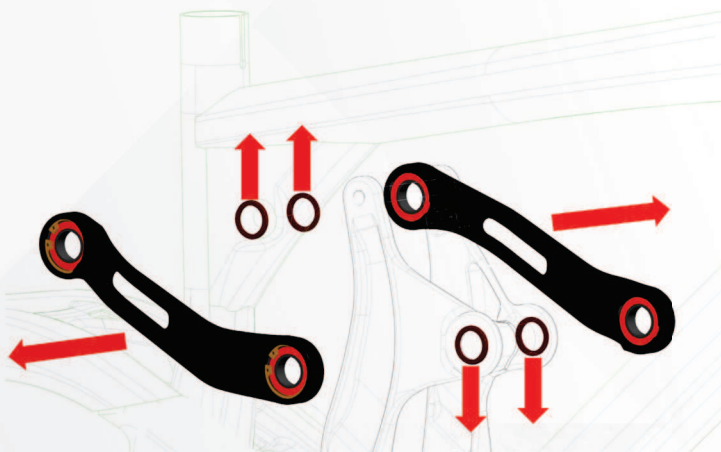

GAMBLER 2013 TOOLSET



Linkage Pivot Disassemble

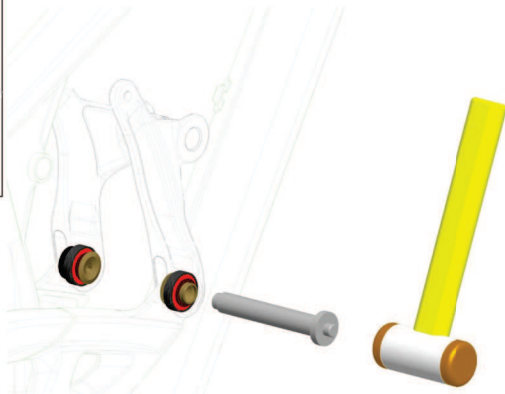
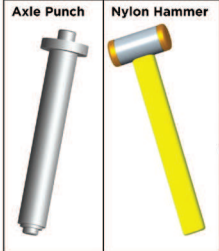

Same step LEFT and RIGHT side



Linkage Disassemble



Linkage Pivot Disassemble

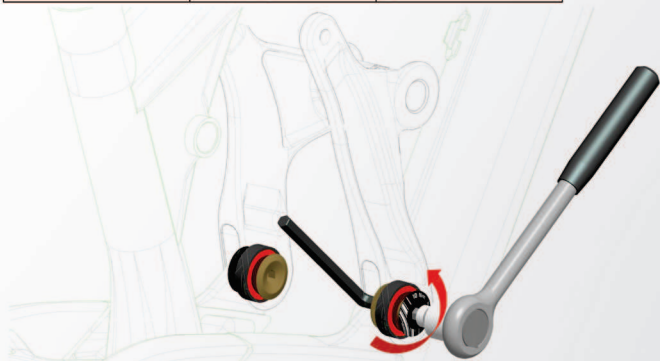

Same step LEFT and RIGHT side

GAMBLER 2013 TOOLSET



Main Pivot Disassemble

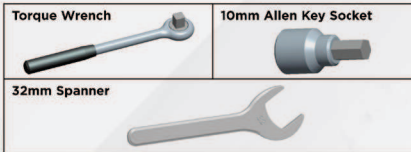

Main Pivot Disassemble

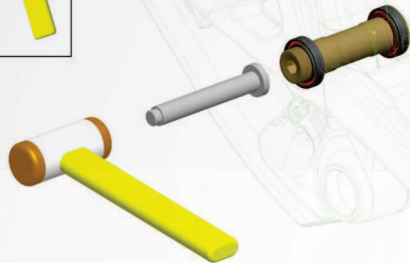
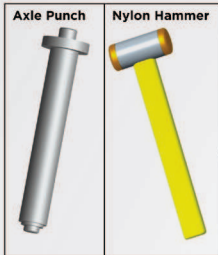

Rear Triangle Disassemble

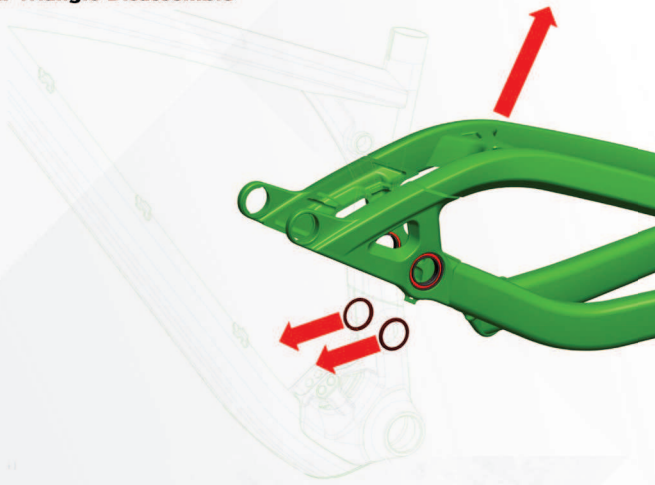

GAMBLER 2013 TOOLSET



Bearing Removal

M8 x 55 Bolt, Nut, Washers 	6902 Bearing Tube 	6902 Bearing Punch
13mm Spanner 	6mm Allen Key 	6902 Plate

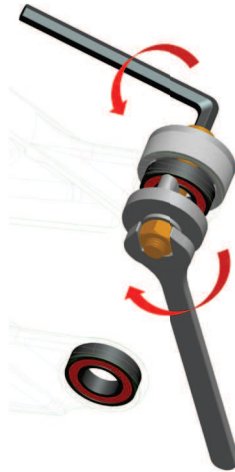
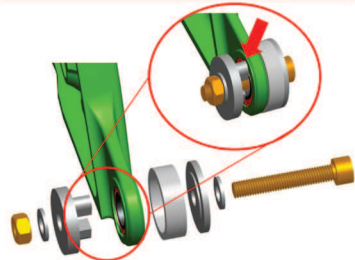

Same step LEFT and RIGHT side



Main Pivot bearings removal

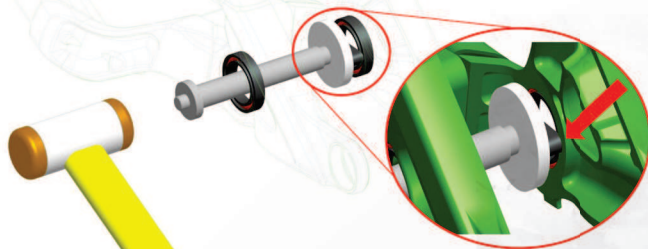

Nylon Hammer 	
Axle Punch 	61805 Bearing Punch

Same step LEFT and RIGHT side



Main Link bearings removal

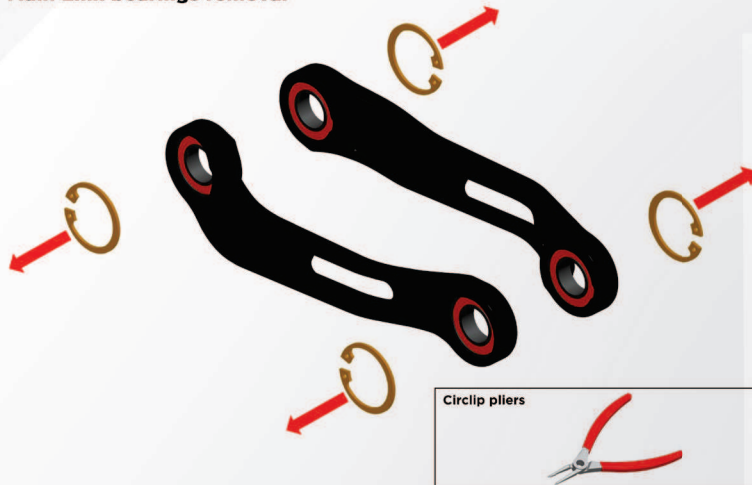

Circlip pliers

GAMBLER 2013 TOOLSET



Main Link bearings removal

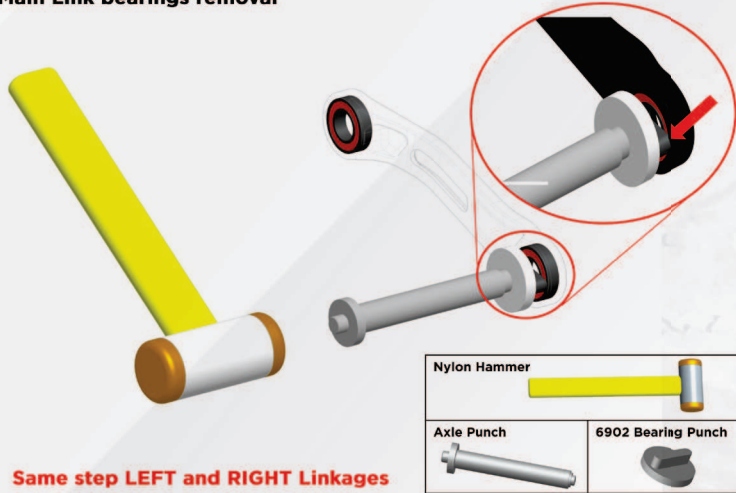

Rear Triangle / Pivot Bearing Install



Main Pivot Bearing Install



GAMBLER 2013 TOOLSET



Main Link Bearing Install

M8 x 55 Bolt, Nut, Washers	
6902 Plate	6902 Press
2x 6902 Bearing	
13mm Spanner	
6mm Allen Key	

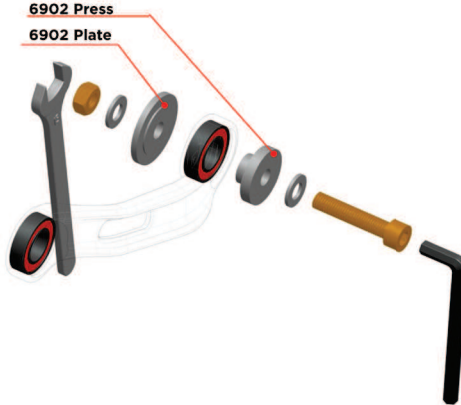

Same step LEFT and RIGHT Linkages



Main Link Bearing Install



Rear Triangle Assembly

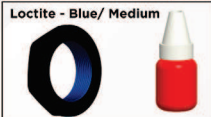

SAME FOR ALL BEARING WASHERS

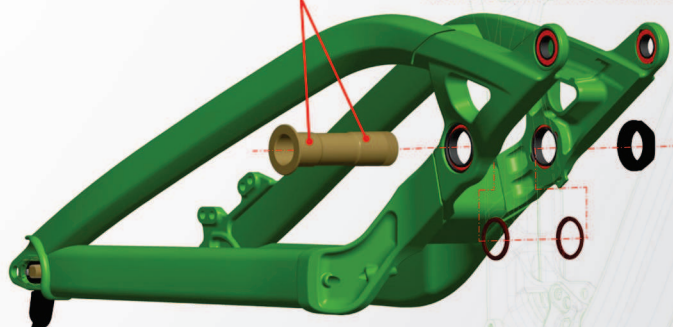

GAMBLER 2013 TOOLSET



Main Pivot assembly

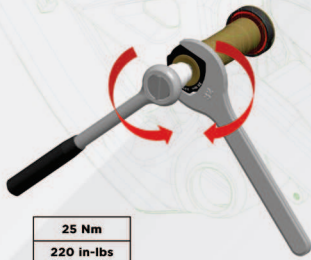
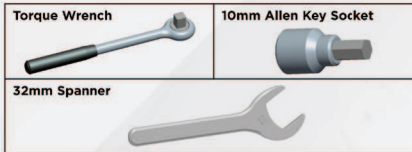

25 Nm
220 in-lbs



Linkage Pivot Pre-Assembly

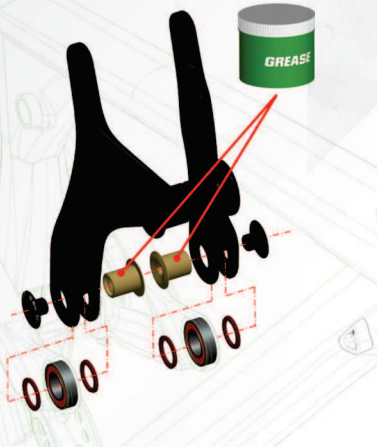
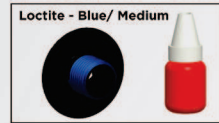

Linkage Pivot Assembly



10 Nm
88 in-lbs

Same step LEFT and RIGHT side



GAMBLER 2013 TOOLSET



Linkage Hardware Pre-Assembly

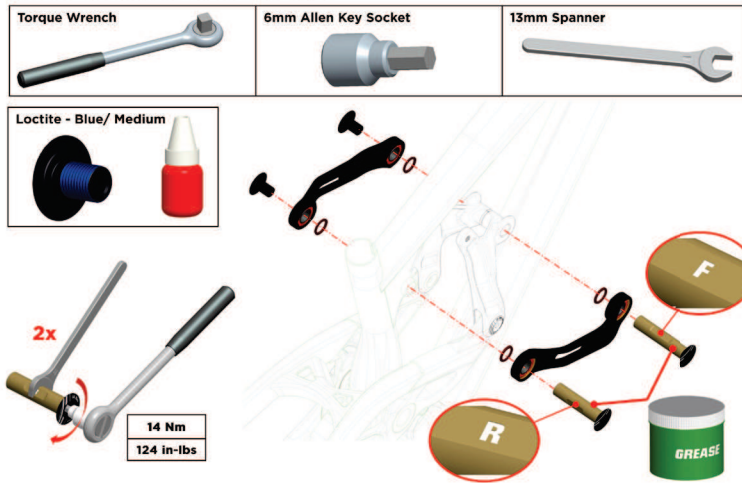

Linkage Hardware Assembly

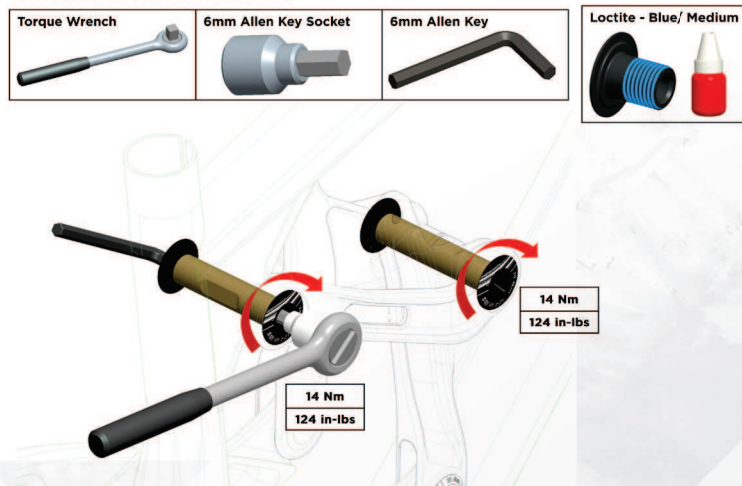

The bearings are standard size and can also be ordered in local hardware stores, in case customers do not want to replace all parts.

One frame needs following bearings:

2 x 61805 (25 x 37 x 7)

6 x 6902 (15 x 28 x 7)

